

# 2467VA1 (hoja 1)

JOHN DEERE 730 - 2 CILINDROS

1960/1974

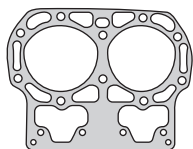
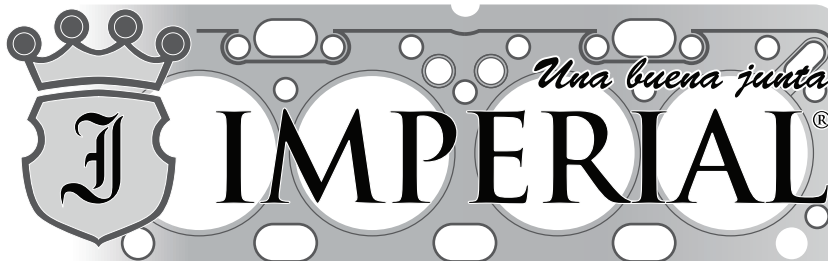

2412CH2 / R21449



2413CG1 / F1898



2415AD3  
F1752



2414AM1 / J10109



2418AD3  
F1779



2417AD3  
F519

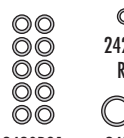

2420P01  
B264



2422C03  
R463



2419GS1  
F1056

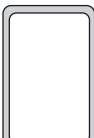

2416CG1 / R61



2421AL1 / A3439

Nº DE CONJUNTO 2423VA1/AJ10208



2428AD3  
F1777



2425CG1  
R20037



2450AD3  
J10081

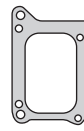

2405AD3  
R20169



2427AD3  
F2699



2468AD3  
F2043



2429AC1  
F2438



2430GS1  
F3450



2431GS1  
A4365



2522GS1  
R495

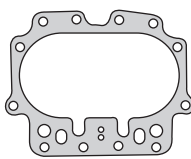

2424AM1 / F2251



2426CG1  
F1803

Nº DE CONJUNTO 2432VA1/AJ10207

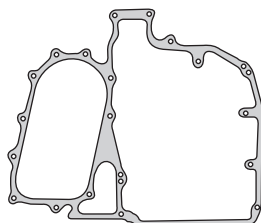

2401AD3 / F2589

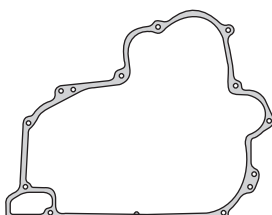

2400AD3 / F2504

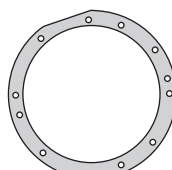

2408AD3 / F1396



2402AD3  
R20232

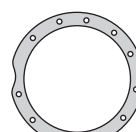

2406AD3  
F1922

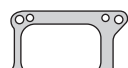

2405AD3  
R20169



2426CG1  
F1803



2403AD3 / F157



2407GS1  
A3817



2522GS1  
R495



2409GS1  
A4224

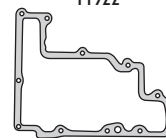

2410AD3 / F2041

Nº DE CONJUNTO 2401VA1/AJ10206

\* Se incluye juego de ARANDELAS

Nº Imperial	Nº Original	Descripción	Nº Imperial	Nº Original	Descripción
2412CH2	R-21449	JUNTA TAPA DE CILINDRO	2416CG1	R-61	JUNTA BOMBA INYECTORA
2413CG1	F-1898	JUNTA TAPA DE VÁLVULA	2417AD3	F-519	JUNTA ENTRADA DE AGUA
2414AM1	J-10109	JUNTA MÚLTIPLE DE ESCAPE	2418AD3	F-1779	JUNTA SALIDA DE AGUA
2415AD3	F-1752	JUNTA MÚLTIPLE DE ADMISIÓN	2424AM1	F-2251	JUNTA BASE DE CILINDRO
2450AD3	J-10081AD3	JUNTA CUERPO BOMBA DE AGUA	2425CG1	R-20037	JUNTA PURIFICADOR DE AIRE
2427AD3	F-2699	JUNTA TAPA TERMOSTATO	2428AD3	F-1777	JUNTA SALIDA DE AGUA A BLOCK
2400AD3	F-2504	J. CUBIERTA REDUCCIÓN ENGRANAJE (TAPA DISTRIBUCIÓN)	2429AC1	F-2438	JUNTA SOPORTE BOMBA INYECTORA
2401AD3	F-2589	J. CUBIERTA REGULACIÓN ENGRANAJE (PLACA DISTRIBUCIÓN)	2468AD3	F-2043	JUNTA CAJA PALANCA REGULADOR
2402AD3	R-20232	JUNTA CAJA RETÉN ACEITE	2409GS1	A-4224	ORING ESPACIADOR VOLANTE
2403AD3	F-157	JUNTA FRENO MOTOR	2419GS1	F-1056	ORING CAÑO INFERIOR BOMBA DE AGUA
2426CG1	F-1803	JUNTA TAPA CAJA CIGÜEÑAL / CUBIERTA CÁRTER	2430GS1	F-3450	ORING CAÑO SUPERIOR ENTRADA DE AGUA
2405AD3	R-20169	JUNTA SOPORTE MOTOR ARRANQUE	2431GS1	A-4365	ORING TUBO ENTRADA DE ACEITE
2406AD3	F-1922	JUNTA CAJA COJINETE PRINCIPAL L.D.	2522GS1	R-495	ORING TUBO VENTILACIÓN MOTOR
2407CG1	A-3817	JUNTA TAPA EJE DE MANDO COJINETE EXTERIOR	2420P01	B-264	ARANDELA ESPÁRRAGO TAPA DE CILINDRO
2408AD3	F-1396	JUNTA RETÉN ACEITE DE POLEA	2421AL1	A-3439	ARANDELA SOPORTE BALANCINES
2410AD3	F-2041	JUNTA CAJA REGULADOR	2422C03	R-463	ARANDELA INYECTOR

# 2467VA1 (hoja 2)

JOHN DEERE 730 - 2 CILINDROS

1960/1974

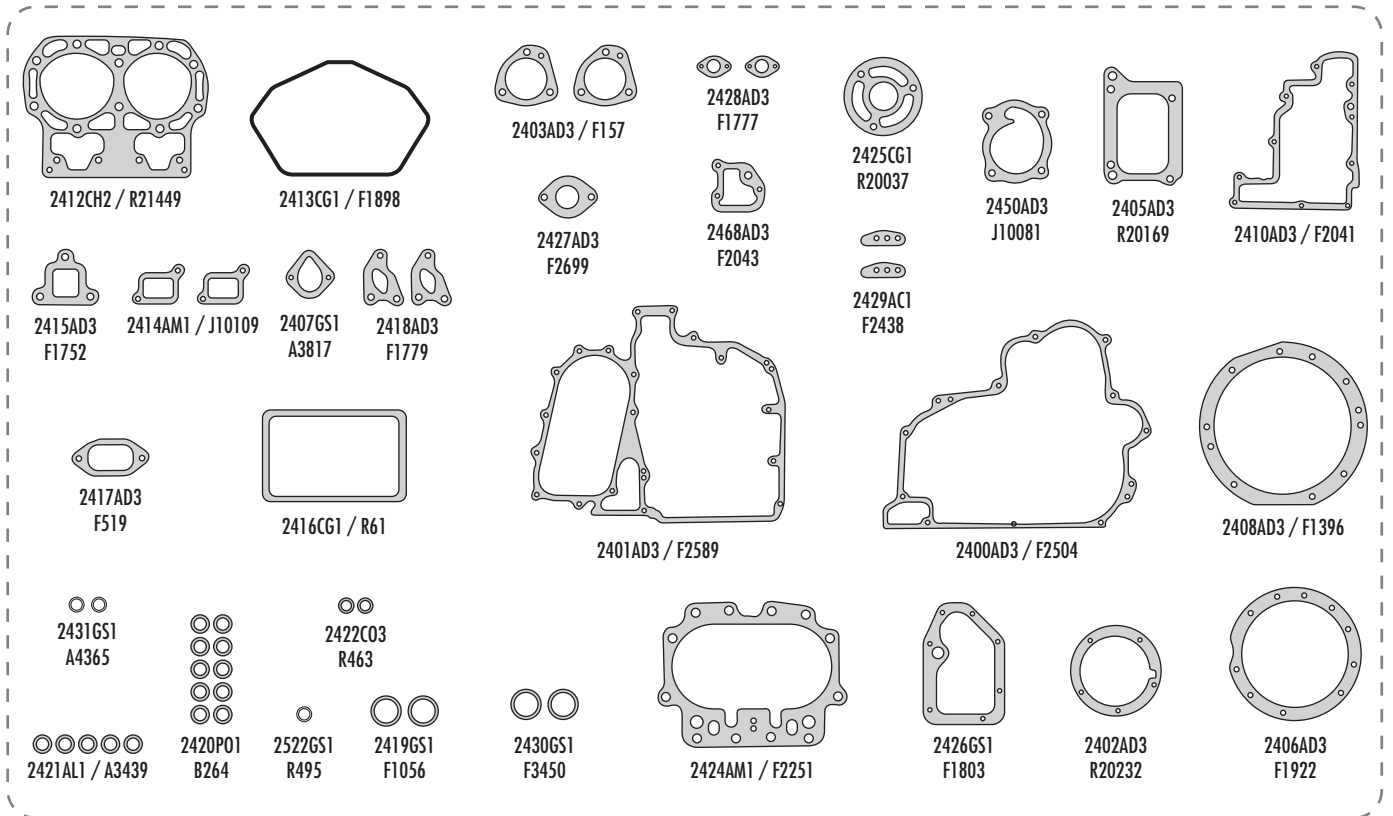
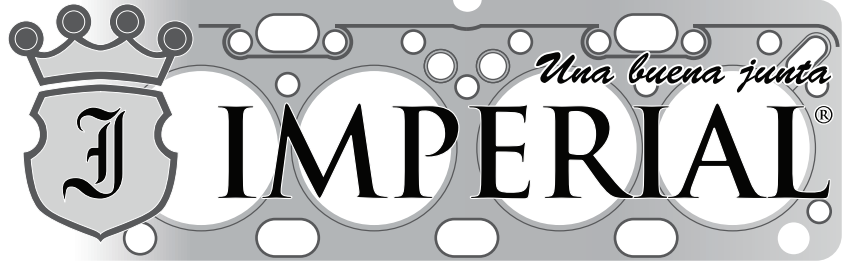

Nº DE CONJUNTO 2467VA1

\* Se incluye juego de ARANDELAS

Nº Imperial	Nº Original	Descripción	Nº Imperial	Nº Original	Descripción
2412CH2	R-21449	JUNTA TAPA DE CILINDRO	2416CG1	R-61	JUNTA BOMBA INYECTORA
2413CG1	F-1898	JUNTA TAPA DE VÁLVULA	2417AD3	F-519	JUNTA ENTRADA DE AGUA
2414AM1	J-10109	JUNTA MÚLTIPLE DE ESCAPE	2418AD3	F-1779	JUNTA SALIDA DE AGUA
2415AD3	F-1752	JUNTA MÚLTIPLE DE ADMISIÓN	2424AM1	F-2251	JUNTA BASE DE CILINDRO
2450AD3	J-10081AD3	JUNTA CUERPO BOMBA DE AGUA	2425CG1	R-20037	JUNTA PURIFICADOR DE AIRE
2427AD3	F-2699	JUNTA TAPA TERMOSTATO	2428AD3	F-1777	JUNTA SALIDA DE AGUA A BLOCK
2400AD3	F-2504	J. CUBIERTA REDUCCIÓN ENGRANAJE (TAPA DISTRIB.)	2429AC1	F-2438	JUNTA SOPORTE BOMBA INYECTORA
2401AD3	F-2589	J. CUBIERTA REGULACIÓN ENGRANAJE (PLACA DISTRIB.)	2468AD3	F-2043	JUNTA CAJA PALANCA REGULADOR
2402AD3	R-20232	JUNTA CAJA RETÉN ACEITE	2409GS1	A-4224	ORING ESPACIADOR VOLANTE
2403AD3	F-157	JUNTA FRENO MOTOR	2419GS1	F-1056	ORING CAÑO INFERIOR BOMBA DE AGUA
2426CG1	F-1803	JUNTA TAPA CAJA CIGÜEÑAL / CUBIERTA CÁRTER	2430GS1	F-3450	ORING CAÑO SUPERIOR ENTRADA DE AGUA
2405AD3	R-20169	JUNTA SOPORTE MOTOR ARRANQUE	2431GS1	A-4365	ORING TUBO ENTRADA DE ACEITE
2406AD3	F-1922	JUNTA CAJA COJINETE PRINCIPAL L.D.	2522GS1	R-495	ORING TUBO VENTILACIÓN MOTOR
2407CG1	A-3817	JUNTA TAPA EJE DE MANDO COJINETE EXTERIOR	2420P01	B-264	ARANDELA ESPÁRRAGO TAPA DE CILINDRO
2408AD3	F-1396	JUNTA RETÉN ACEITE DE POLEA	2421AL1	A-3439	ARANDELA SOPORTE BALANCINES
2410AD3	F-2041	JUNTA CAJA REGULADOR	2422C03	R-463	ARANDELA INYECTOR

# 2467VA1 (hoja 3)

JOHN DEERE 730 - 2 CILINDROS

1960/1974

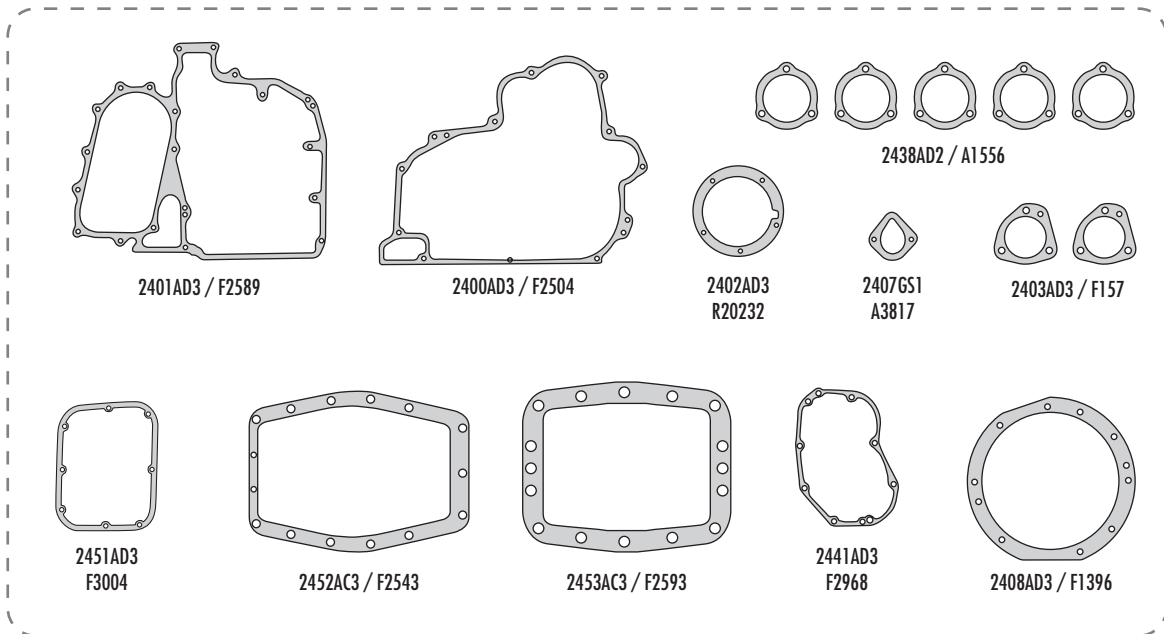
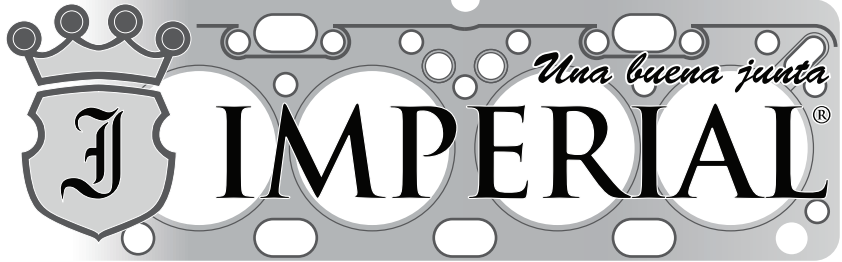

Nº DE CONJUNTO 2434VA1/AF3357

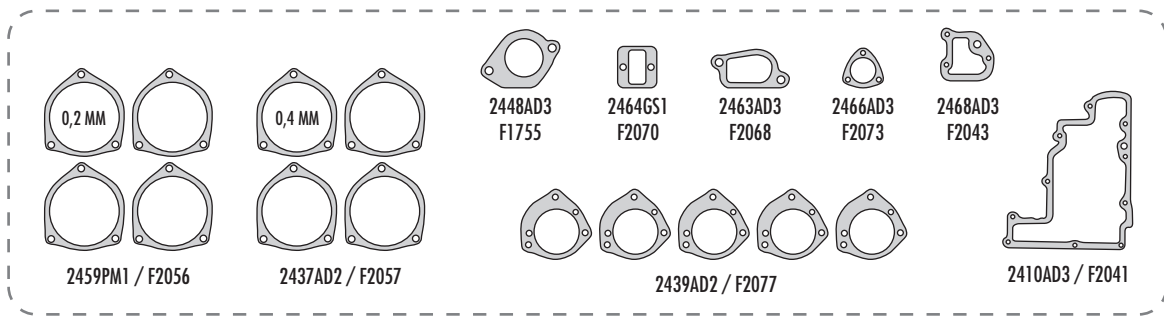

Nº DE CONJUNTO 2433VA1/AF2244

\* Se incluye juego de ARANDELAS

Nº Imperial	Nº Original	Descripción	Nº Imperial	Nº Original	Descripción
2400AD3	F-2504	J. CUBIERTA REDUCCIÓN ENGRANAJE (TAPA DISTRIB.)	2441AD3	F-2968	JUNTA TAPA CUBIERTA EMBRAGUE
2401AD3	F-2589	J. CUBIERTA REGULACIÓN ENGRANAJE (PLACA DISTRIB.)	2448AD3	F-1755	JUNTA BOMBA COMBUSTIBLE
2402AD3	R-20232	JUNTA CAJA RETÉN ACEITE	2451AD3	F-3004	JUNTA TAPA CAJA DE CAMBIO
2403AD3	F-157	JUNTA FRENO MOTOR	2452AC3	F-2543	JUNTA TAPA CAJA DIFERENCIAL
2407CG1	A-3817	JUNTA TAPA EJE DE MANDO COJINETE EXTERIOR	2453AC3	F-2593	JUNTA TAPA CAÑONERA
2408AD3	F-1396	JUNTA RETÉN ACEITE DE POLEA	2459PM1	F-2056	JUNTA TAPA COJINETE EJE REGULADOR
2410AD3	F-2041	JUNTA CAJA REGULADOR	2463AD3	R-2068	JUNTA TAPA CONTROL VELOCIDAD
2437AD2	F-2057	JUNTA TAPA COJINETE EJE REGULADOR	2464CG1	F-2070	JUNTA TAPA CAJA CUBIERTA REGULADOR
2438AD2	A-1556AD2	JUNTA TOMA FUERZA RUEDA DELANTERA	2466AD3	F-2073	JUNTA TAPA CONTROL DE HORAS
2439AD2	F-2077AD2	JUNTA TAPA TRASERA CAJA COJINETE VENTILADOR	2468AD3	F-2043	JUNTA CAJA PALANCA REGULADOR

# 2527VA1

JOHN DEERE 1420 - 3 CILINDROS

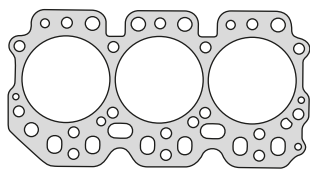
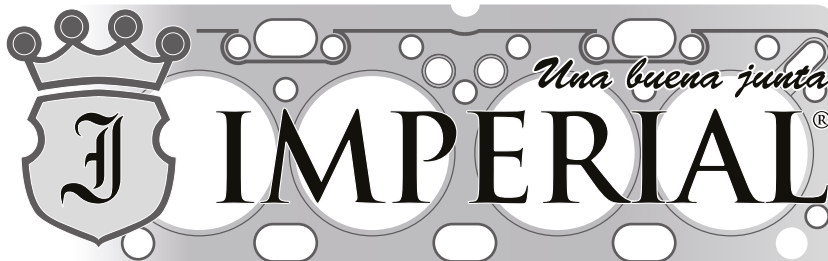

2500AM1 / T20039

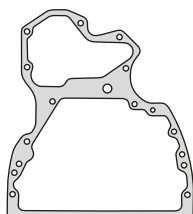

2502AC3 / T24965

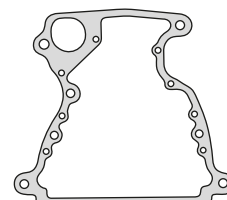

2503AC3 / T23596

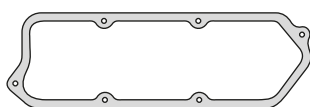

2509CG1 / T20111



2510HH1 / T20006



2505AC3  
T20271

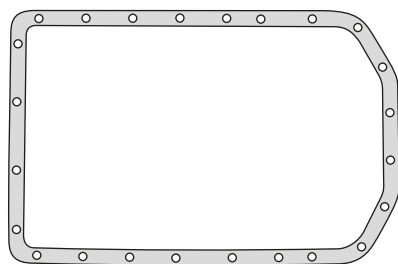

2514AC3 / T24534

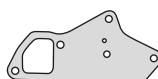

2506AC3 / T20243



2504AC3  
T20273



2511AC3  
T20336



2517AC3  
T20159

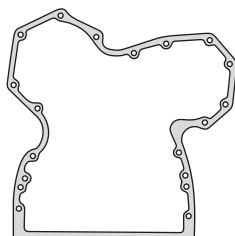

2501AC3 / T20155



2518AC3  
R27285



2513AC3  
T24460



2516AC3  
T20364



2519AM1  
T20141



2568CG1  
J52942



2519AM1  
T20141



2512CG1  
T20328



2521GS1  
R27166



2522GS1  
R495



2507AC3  
T20215



2508AC3  
T20219

\* Se incluye juego de ARANDELAS

Nº Imperial	Nº Original	Descripción	Nº Imperial	Nº Original	Descripción
2500AM1	R-515273	JUNTA TAPA DE CILINDRO	2511AC3	T-20336	JUNTA BASE BOCA LLENADO ACEITE
2509CG1	T-20111	JUNTA TAPA DE VÁLVULA	2512AC3	T-20328	JUNTA TAPA BOCA LLENADO ACEITE
2514AC3	T-24534	JUNTA DE CÁRTER	2513AC3	T-24460	JUNTA BOMBA INYECTORA
2510HH1	T-20006	JUNTA MÚLTIPLE DE ESCAPE	2516AC3	T-20364	JUNTA TAPA ENGRANAJE BOMBA INYECTORA
2501AC3	T-20155	JUNTA TAPA DE DISTRIBUCIÓN	2517AC3	T-20159	JUNTA ENTRADA DE AIRE
2502AC3	T-24965	JUNTA PLACA DE DISTRIBUCIÓN	2518AC3	R-27285	JUNTA BOMBA COMBUSTIBLE
2503AC3	T-23596	JUNTA PLACA CAJA VOLANTE	2519AC3	T-20141	JUNTA BASE SILENCIADOR
2504AC3	T-20273	JUNTA TAPA ENGRANAJE DISTRIBUCIÓN	2521GS1	R-27166	ORING TUBO SUCCIÓN BOMBA ACEITE
2505AC3	T-20271	JUNTA CUERPO BOMBA DE AGUA	2522GS1	R-495	ORING TUBO VENTILACIÓN MOTOR
2505AD3	T-20271AD3	JUNTA CUERPO BOMBA DE AGUA	2568CG1	J-52942	JUNTA VASO BOMBA COMBUSTIBLE
2506AC3	T-20243	JUNTA BASE BOMBA DE AGUA	2523SL1	AR-71618	JUEGO ORING ANILLO DE CAMISA
2506AD3	T-20243AD3	JUNTA BASE BOMBA DE AGUA	2523VT1	AR-71618	JUEGO ORING ANILLO DE CAMISA
2507AC3	T-20215	JUNTA TAPA TERMOSTATO	2527VA1		JUEGO DE JUNTAS PARA MOTOR (S/JTA T.CIL.Y S/ORING CAMISA)
2508AC3	T-20219	JUNTA BASE TERMOSTATO	2524AM1		JUEGO DE JUNTAS PARA MOTOR COMPLETO

# 2549VA1

JOHN DEERE 2420 - 4 CILINDROS

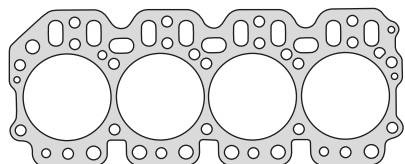
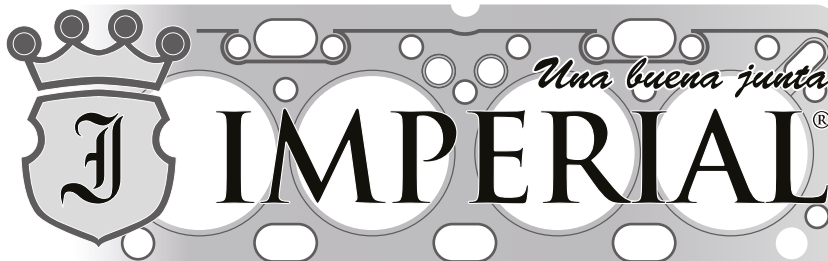

2541AM1 / R515274

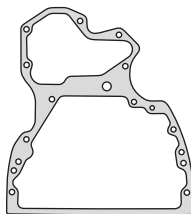

2502AC3 / T24965

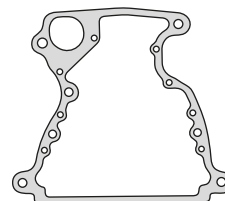

2503AC3 / T23596

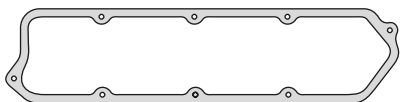

2542CG1 / T20075

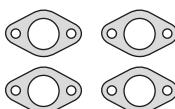

2510HH1 / T20006

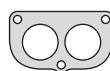

2585AC3  
R54638



2584AC3  
R54641

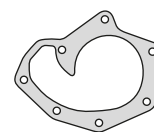

2505AC3  
T20271

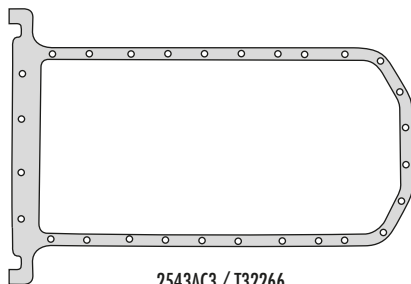

2543AC3 / T32266

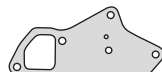

2506AC3 / T20243



2504AC3  
T20273



2511AC3  
T20336



2517AC3  
T20159

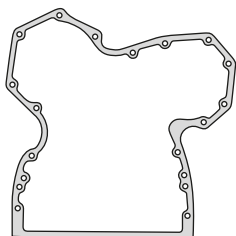

2501AC3 / T20155



2518AC3  
R27285



2513AC3  
T24460



2516AC3  
T20364



2519AM1  
T20141



2568CG1  
J52942



2523SL1 / 2523VT1  
AR71618



2512CG1  
T20328



2521GS1  
R27166



2522GS1  
R495



2507AC3  
T20215



2508AC3  
T20219

\* Se incluye juego de ARANDELAS

Nº Imperial	Nº Original	Descripción	Nº Imperial	Nº Original	Descripción
2541AM1	R-515274	JUNTA TAPA DE CILINDRO	2512AC3	T-20328	JUNTA TAPA BOCA LLENADO ACEITE
2542CG1	T-20075	JUNTA TAPA DE VÁLVULA	2513AC3	T-24460	JUNTA BOMBA INYECTORA
2543AC3	T-32266	JUNTA DE CÁRTER	2516AC3	T-20364	JUNTA TAPA ENGRANAJE BOMBA INYECTORA
2510HH1	T-20006	JUNTA MÚLTIPLE DE ESCAPE	2517AC3	T-20159	JUNTA ENTRADA DE AIRE
2501AC3	T-20155	JUNTA TAPA DE DISTRIBUCIÓN	2518AC3	R-27285	JUNTA BOMBA COMBUSTIBLE
2502AC3	T-24965	JUNTA PLACA DE DISTRIBUCIÓN	2519AM1	T-20141	JUNTA BASE SILENCIADOR
2503AC3	T-23596	JUNTA PLACA CAJA VOLANTE	2521GS1	R-27166	ORING TUBO SUCCIÓN BOMBA ACEITE
2504AC3	T-20273	JUNTA TAPA ENGRANAJE DISTRIBUCIÓN	2522GS1	R-495	ORING TUBO VENTILACIÓN MOTOR
2505AC3	T-20271	JUNTA CUERPO BOMBA DE AGUA	2568CG1	J-52942	JUNTA VASO BOMBA COMBUSTIBLE
2505AD3	T-20271AD3	JUNTA CUERPO BOMBA DE AGUA	2584AC3	R-54641	JUNTA LATERAL TERMOSTATO
2506AC3	T-20243	JUNTA BASE BOMBA DE AGUA	2585AC3	R-54638	JUNTA SUPERIOR TERMOSTATO
2506AD3	T-20243AD3	JUNTA BASE BOMBA DE AGUA	2523SL1	AR-71618	JUEGO ORING ANILLO DE CAMISA
2507AC3	T-20215	JUNTA TAPA TERMOSTATO	2523VT1	AR-71618	JUEGO ORING ANILLO DE CAMISA
2508AC3	T-20219	JUNTA BASE TERMOSTATO	2549VA1		JUEGO DE JUNTAS PARA MOTOR (S/JTA T.CILY S/ORING CAMISA)
2511AC3	T-20336	JUNTA BASE BOCA LLENADO ACEITE	2545AM1		JUEGO DE JUNTAS PARA MOTOR COMPLETO

# 2596AM1

JOHN DEERE 2730 - 4 CILINDROS

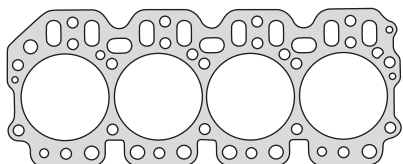
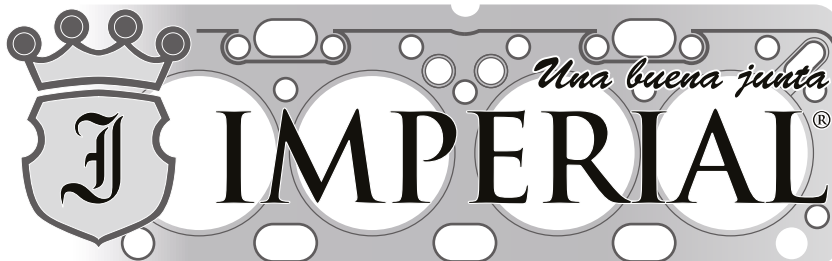

2541AM1 / R515274

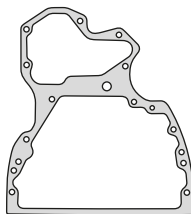

2502AC3 / T24965

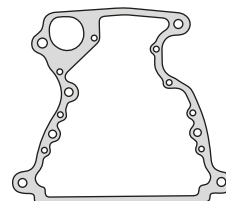

2503AC3 / T23596

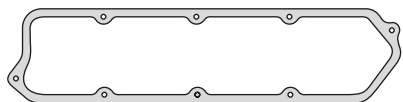

2542CG1 / T20075

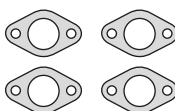

2510HH1 / T20006

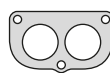

2585AC3  
R54638



2584AC3  
R54641

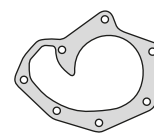

2505AC3  
T20271

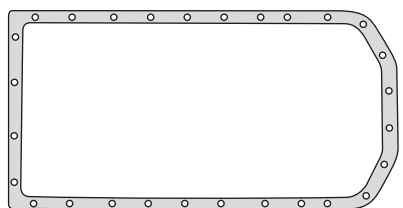

2591AC3 / T24535

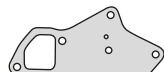

2506AC3 / T20243



2504AC3  
T20273



2511AC3  
T20336



2517AC3  
T20159

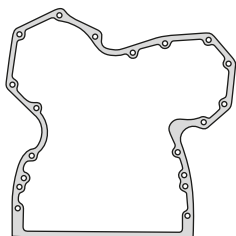

2501AC3 / T20155



2518AC3  
R27285



2513AC3  
T24460



2516AC3  
T20364



2519AM1  
T20141



2568CG1  
J52942



2590SL1 / 2590VT1  
AR65507



2512CG1  
T20328



2521GS1  
R27166



2522GS1  
R495



2507AC3  
T20215



2508AC3  
T20219

\* Se incluye juego de ARANDELAS

Nº Imperial	Nº Original	Descripción	Nº Imperial	Nº Original	Descripción
2541AM1	R-515274	JUNTA TAPA DE CILINDRO	2512AC3	T-20328	JUNTA TAPA BOCA LLENADO ACEITE
2542CG1	T-20075	JUNTA TAPA DE VÁLVULA	2513AC3	T-24460	JUNTA BOMBA INYECTORA
2543AC3	T-32266	JUNTA DE CÁRTER	2516AC3	T-20364	JUNTA TAPA ENGRANAJE BOMBA INYECTORA
2510HH1	T-20006	JUNTA MÚLTIPLE DE ESCAPE	2517AC3	T-20159	JUNTA ENTRADA DE AIRE
2501AC3	T-20155	JUNTA TAPA DE DISTRIBUCIÓN	2518AC3	R-27285	JUNTA BOMBA COMBUSTIBLE
2502AC3	T-24965	JUNTA PLACA DE DISTRIBUCIÓN	2519AM1	T-20141	JUNTA BASE SILENCIADOR
2503AC3	T-23596	JUNTA PLACA CAJA VOLANTE	2521GS1	R-27166	ORING TUBO SUCCIÓN BOMBA ACEITE
2504AC3	T-20273	JUNTA TAPA ENGRANAJE DISTRIBUCIÓN	2522GS1	R-495	ORING TUBO VENTILACIÓN MOTOR
2505AC3	T-20271	JUNTA CUERPO BOMBA DE AGUA	2568CG1	J-52942	JUNTA VASO BOMBA COMBUSTIBLE
2505AD3	T-20271AD3	JUNTA CUERPO BOMBA DE AGUA	2584AC3	R-54641	JUNTA LATERAL TERMOSTATO
2506AC3	T-20243	JUNTA BASE BOMBA DE AGUA	2585AC3	R-54638	JUNTA SUPERIOR TERMOSTATO
2506AD3	T-20243AD3	JUNTA BASE BOMBA DE AGUA	2523SL1	AR-71618	JUEGO ORING ANILLO DE CAMISA
2507AC3	T-20215	JUNTA TAPA TERMOSTATO	2523VT1	AR-71618	JUEGO ORING ANILLO DE CAMISA
2508AC3	T-20219	JUNTA BASE TERMOSTATO	2549VA1		JUEGO DE JUNTAS PARA MOTOR (S/JTA T.CILY S/ORING CAMISA)
2511AC3	T-20336	JUNTA BASE BOCA LLENADO ACEITE	2545AM1		JUEGO DE JUNTAS PARA MOTOR COMPLETO

# 25968VA1

JOHN DEERE 6300 - 4 CILINDROS

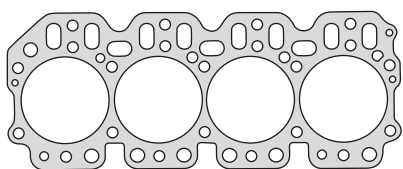
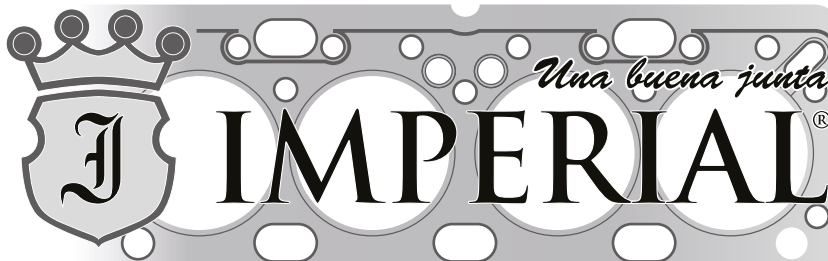

2541AM1 / R515274

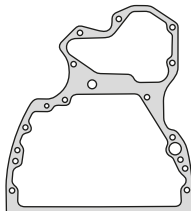

25936AC3 / R90648

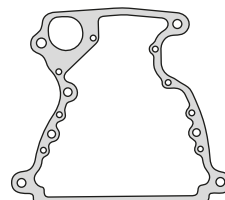

25938AC3 / R97351

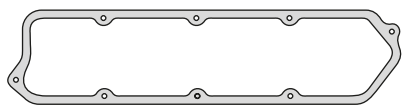

25931AM1 / R73251



25932A01 / R119395



2516AC3 / T20364



25939A01 / R89879

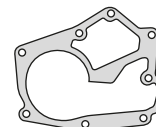

2561AC3 / T25485

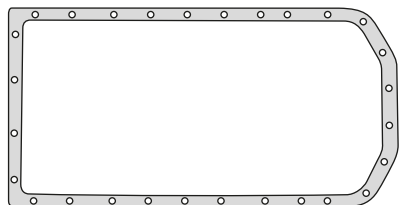

25934AC3 / R119360

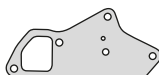

2506AC3 / T20243



25940AC3 / R43416



2511AC3 / T20336



25933AC6 / R81275



25942AC3 / R97354



25941GS1 / T16318



25951VT1 / R61871



25952GS1 / R74354



25950GS1 / R56463



25935SL1 / R97877

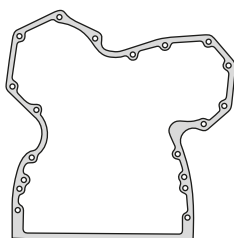

25937AC3 / R126513



2590SL1 / 2590VT1 / AR65507



2512CG1 / T20328



25953AL1 / R120247



25954GS1 / R56461



2508AC3 / T20219

\* Se incluye juego de ARANDELAS

Nº Imperial	Nº Original	Descripción	Nº Imperial	Nº Original	Descripción
25931AM1	R-73251	JUNTA TAPA DE VÁLVULA - ALMETAN	25937AC3	R-126513	JUNTA TAPA DE DISTRIBUCIÓN
25934AC3	R-1193600	JUNTA DE CÁRTER	25938AC3	R-97351	JUNTA PLACA CAJA VOLANTE
25932A01	R-119395	JUNTA MÚLTIPLE DE ESCAPE	25939A01	R-89879	JUNTA BASE TURBO A MÚLTIPLE
2506AC3	T-20243	JUNTA BASE BOMBA DE AGUA	25940AC3	R-43416	JUNTA DRENAJE ACEITE TURBO
2506AD3	T-20243AD3	JUNTA BASE BOMBA DE AGUA	25941GS1	T-16318	ORING BOMBA DE COMBUSTIBLE
2511AC3	T-20336	JUNTA BASE BOCA LLENADO ACEITE	25942AC3	R-97354	JUNTA BOMBA INYECTORA
2512AC3	T-20328	JUNTA TAPA BOCA LLENADO ACEITE	25950GS1	R-56463	ORING CAÑO RESPIRADERO
2516AC3	T-20364	JUNTA TAPA ENGRANAJE BOMBA INYECTORA	25951VT1	R-61871	ORING ENTRADA BOMBA DE ACEITE
2561AC3	T-25485	JUNTA CUERPO BOMBA DE AGUA	25952GS1	R-74354	ORING SALIDA BOMBA DE ACEITE
2561AD3	T-25485AD3	JUNTA CUERPO BOMBA DE AGUA	25953AL1	R-120247	ARANDELA TAPON CÁRTER
25933AC6	R-81275	JUNTA ENTRADA DE AIRE	25954GS1	R-56461	ORING CAÑO LLENADO ACEITE
25935SL1	R-97877	ORING TERMOSTATO	25968VA1		JUEGO DE JUNTAS PARA MOTOR (S/JTA T.CIL.Y S/ORING CAMISA)
25936AC3	R-90648	JUNTA PLACA DE DISTRIBUCIÓN			
<b>DEMÁS JUNTAS RELACIONADAS AL MOTOR - NO SE COLOCAN EN EL JUEGO DE JUNTAS</b>					
2541AM1	R-515274	JUNTA TAPA DE CILINDRO	2590VT1	AR-65507	JUEGO ORING ANILLO DE CAMISA
2590SL1	AR-65507	JUEGO ORING ANILLO DE CAMISA			